



Industrial PC

PPC-A9-121-U-C



PN: CS10768F121-U

Content can change at anytime, check our website for latest information of this product.

www.chipsee.com

Contents

PPC-A9-121-U-C	3
1. Product Overview	7
2. Ordering Options	8
2.1. Operating System	8
2.2. Optional Features	9
3. Hardware Features	10
4. Power Input	12
5. Touch Screen	13
6. Connectivity	14
6.1. RS232/RS485/CAN	14
6.2. USB Connectors	16
6.3. LAN Connectors	17
6.4. WiFi & BT Module	18
6.5. 4G/LTE Module	19
6.6. Camera, Microphone, and Fingerprint Module	20
7. Audio Connector	21
8. HDMI Connector	22
9. Boot DIP Switch	23
10. Mounting Procedure	24
11. Mechanical Specifications	26
12. Disclaimer	27
13. Technical Support	27

PPC-A9-121-U-C

Front View



Rear View

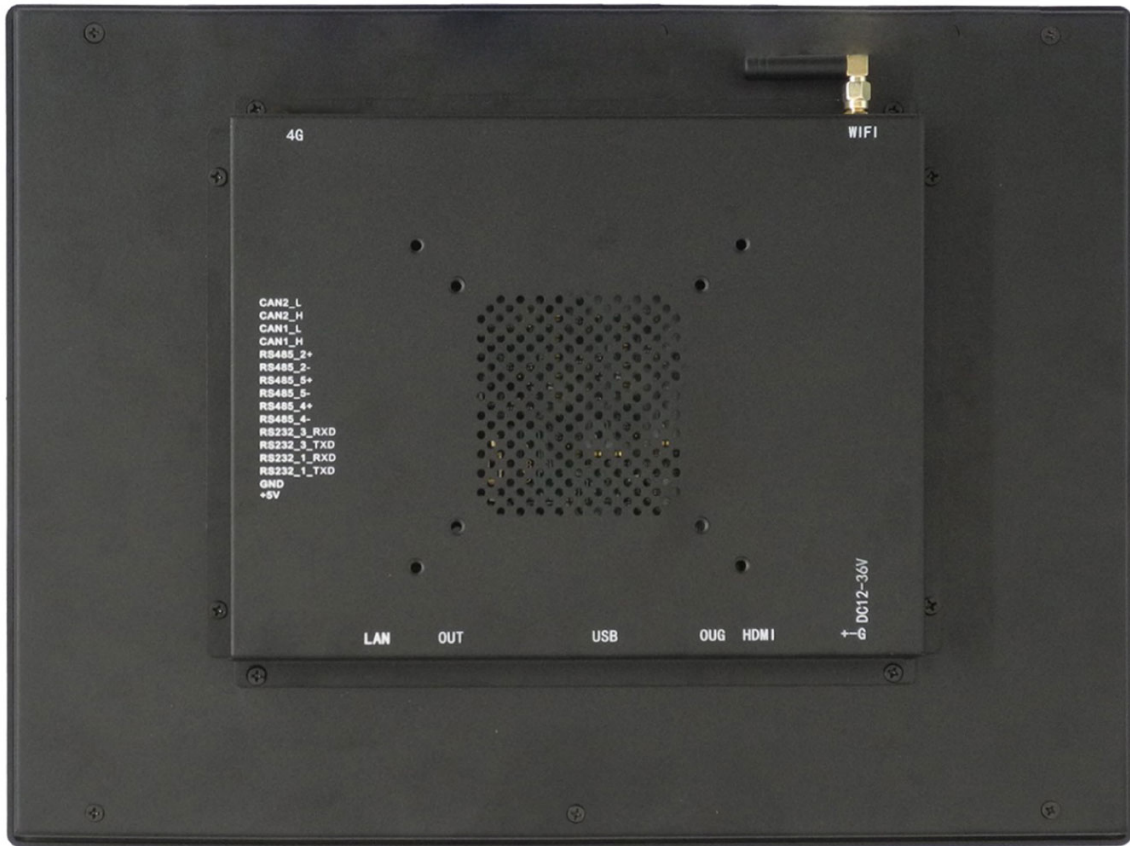

Side View 1



Side View 2



Product Overview

The Cortex[®]-A9 series PPC-A9-121-U-C (PN: CS10768F121-U) is a rugged, high-quality industrial panel PC. It features a 12.1" multi-point capacitive touch screen with a resolution of 1024 x 768 pixels.

Key Applications

- Human Machine Interface HMI
- Process Control
- Process Monitoring
- HMI
- Infotainment
- Predictive Maintenance
- Machine Learning
- Machine Vision
- Automotive applications
- ATM...

The PPC-A9-121-U-C Industrial Panel PC is based around the powerful CS-SOM-iMX6Q System on Module (SoM), powered by the i.MX6Q Arm[®] Cortex[®]-A9 quad-core Application Processor (APU). The i.MX6Q APU represents the latest achievement in integrated multimedia applications processors, delivering high-performance computing, an abundance of integrated peripherals, and high power efficiency.

This product also features a broad range of connectivity options, providing a high level of scalability for various use cases. It is the perfect solution for power-constrained applications on the Edge, acting as a robust control unit for collecting, processing, and aggregating field data. The i.MX6Q APU is part of NXP's EdgeVerse™ edge computing platform.

The NXP i.MX6UL APU does not generate extensive heat, so even the thin aluminum housing on PPC version delivers sufficient thermal dissipation. With its junction temperature from -40 to +125°C, the APU itself is well suited for extended temperature range in both automotive and factory environments.

Ordering Options

Chipsee products can be customized during the ordering process. The product will be shipped with the pre-installed factory defaults if no extra requirements are specified. The table in the [Hardware Features](#) section provides information about the default options bundled with the product.

Note

You can order [PPC-A9-121-U-C](#) from the official [Chipsee Store](#) or from your nearest distributor.

Operating System

This product comes with a pre-installed OS of your choice. Please see the list below for the supported OSes, which can be also obtained from the [Software Documentation](#) section, along with the detailed installation instructions.

- Chipsee Linux*
- Android 4.3
- Android 6.0
- Android 8.0
- Ubuntu 12.04
- Ubuntu 14.04
- Debian

* Chipsee Linux is based on NXP Yocto framework that has been integrated with:

1. Chipsee Hardware Test Application
2. An initialization script for GPIO/Buzzer/Audio
3. Multiple libraries, such as the `libQt5Sql` to develop Qt application with SQL
4. Various packages, such as the `ntfs-3g` to use NTFS file system

Warning

The [Software Documentation](#) section provides a detailed instruction how to install different OS on your own. However, bear in mind that Chipsee can't take the responsibility of inadequate installation procedure. If you "brick" your device, please contact Chipsee Technical Support at support@chipsee.com for further assistance.

Optional Features

The PPC-A9-121-U-C Industrial Panel PC does not include 4G/LTE module by default. The module is optional and can be selected at the Chipsee store during the ordering process.

Warning

Installation, repair, and maintenance tasks should be performed by trained personnel only.
Chipsee does not bear any responsibility for damage caused by inadequate handling of the product.

Hardware Features

The PPC-A9-121-U-C Industrial Panel PC offers a board range of performance and connectivity options for scalable integration, providing expandability according to future needs. Some of the key features are listed in the table below.

PPC-A9-121-U-C	
CPU	iMX6Q, Arm [®] Cortex [®] -A9, 1GHz
RAM	2GB DDR3
eMMC	8GB
Storage	TF Card, Supports up to 32GB SDHC
Display	12.1" LCD, 1024 x 768, High Brightness: 500 cd
Touch	Capacitive Multi-Point Touch Screen
USB	2 x USB 2.0 HOST, 1 x USB OTG
LAN	1 x Channel 1000Mbps LAN
Audio	Mic input, 3.5mm Audio Out Connector, 2W Internal Speaker
Buzzer	Yes
Camera	Yes, Front USB -500 ten thousand pixel
Fingerprint	Zaz-070S
RTC	Yes, Powered by CR2032 Button Battery
RS232	4 x RS232
RS485	2 x RS485 (Optional) ¹
CAN	2 x CAN (Optional)
GPIO	N/A
WiFi/BT	Integrated WiFi/BT Module
HDMI	1 x HDMI
SATA	1 x SATA II
4G/LTE	Optional, Not mounted by default
Power Input	From 15V to 36V
Current at 15V	2000mA Max
Power Consumption	10W Typical
Working Temperature	From -20°C to +70°C
OS	Multiple Choices (Operating System)
Dimensions	359 x 274 x 23mm

PPC-A9-121-U-C	
Weight	4000g
Mounting	Panel & VESA

Table 20 Key Features

-
- 1** This product has 5 x UART channels in total. The default configuration is 2 x RS232, 2 x RS485, and 1 x UART for WiFi/BT module. UART can be swapped between RS232 and RS485 modes easily, so if you need different RS232/RS485 configuration, please get in touch with the Chipsee Technical Support at support@chipsee.com

Power Input

The PPC-A9-121-U-C Industrial Panel PC can be powered by a wide range of input voltages: From 15V to 36V DC. The power input connector is a **3-pin, 3.81mm terminal**. The polarity and the pinout is clearly marked on the housing of the product as shown on the figure below.



Figure 65: Power Input

Note that the “+” sign represents the positive power input, and it is printed both at the casing and as a silk-screen on a PCB of the embedded version. The “-” terminal is shorted to the ground.

Power Input Definition		
Pin Number	Definition	Description
Pin 1	Positive Input	DC Power Positive Terminal
Pin 2	Negative Input	DC Power Negative Terminal
Pin 3	Ground	Power System Ground

Table 21 Power Connector

Note

The system ground “G” is connected to power negative “-” on board.

Touch Screen

The PPC-A9-121-U-C Industrial Panel PC uses a 10-point capacitive touch screen.

Attention

A capacitive touch screen is susceptible to power noise and Electromagnetic Radiation (EMR). It may cause LCD ripples or even capacitive touch malfunction. If using a capacitive multi-touch test application, you might notice the touch points float erratically across the display. There are several solutions to this problem:

1. Use a high-quality Power Adapter Unit (PSU) with low EMR. You can also provide power from a battery.
2. Make sure that the PPC-A9-121-U-C Power Input connector (pin 3) is properly connected to the Power System Ground to provide sufficient EMI shielding and eliminate the problem entirely.
3. Bad GND problem can also be confirmed by touching pin 3 of the Power Input connector with one hand while operating the capacitive touch screen with the other hand. In this case, the operator's body acts as the Power System Ground.

Connectivity

There are many connectivity options available on the PPC-A9-121-U-C industrial PC. It has 2 x HOST USB Type A connectors, 1 x USB OTG Type Mini B, 2 x network connector (RJ45) supporting up to 1 Gbps, and 5 x UART terminals (RS232/485). This device also features two CAN interfaces.

RS232/RS485/CAN

The serial communication interfaces (RS485, RS232, and CAN) are routed to a **16-pin 3.81mm terminal**, as illustrated in the figure below. Serial communication on both RS485 and RS232 interfaces can reach up to 115200 kbps.

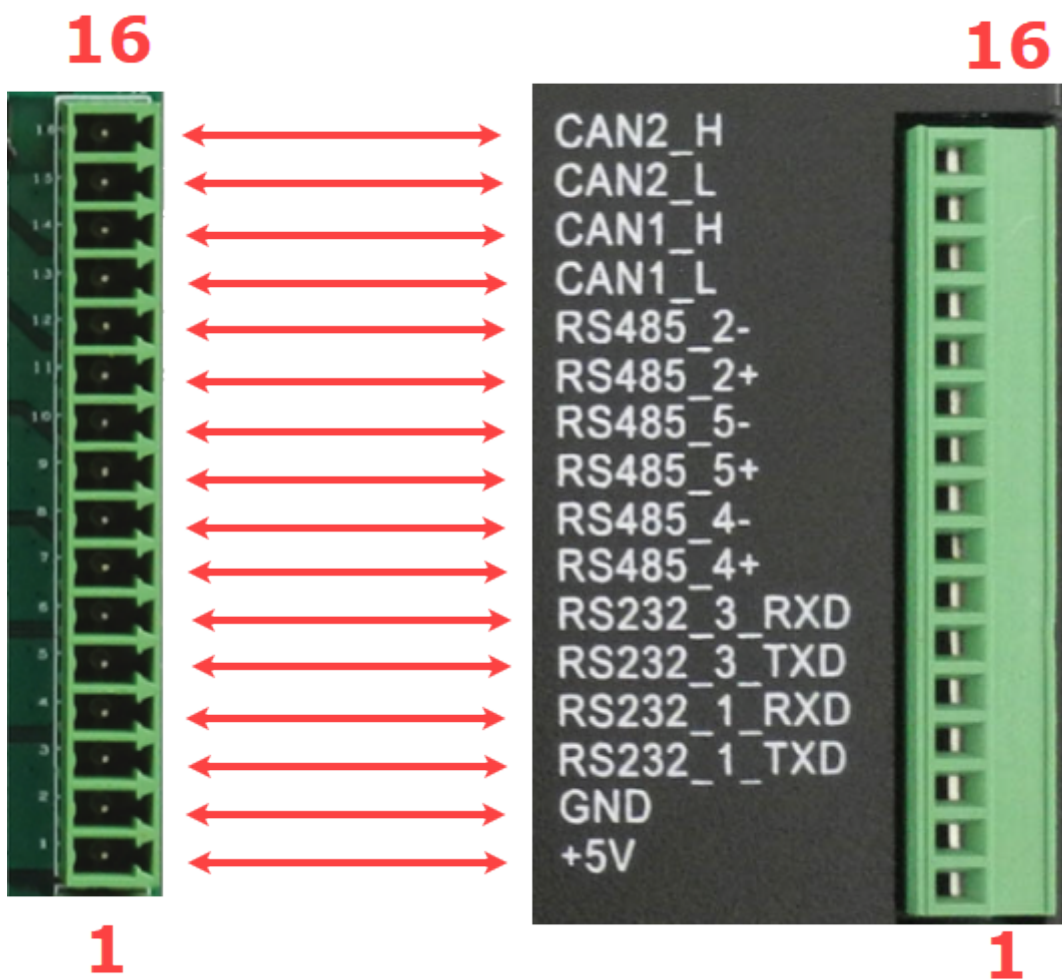

Figure 66: Serial pins connector

The table below offers more detailed description of every pin and its definition:

RS232 / RS485 / CAN Pin Definition:		
Pin Number	Definition	Description
Pin 16	CAN2_H	CPU CAN Channel 2 H signal

Pin 15	CAN2_L	CPU CAN Channel 2 L signal
Pin 14	CAN1_H	CPU CAN Channel 1 H signal
Pin 13	CAN1_L	CPU CAN Channel 1 L signal
Pin 12	RS485_2-	CPU UART2, RS485 -(B) signal 2
Pin 11	RS485_2+	CPU UART2, RS485 +(A) signal 2
Pin 10	RS485_5-	CPU UART5, RS485 -(B) signal
Pin 9	RS485_5+	CPU UART5, RS485 +(A) signal
Pin 8	RS485_4-	CPU UART4, RS485 -(B) signal
Pin 7	RS485_4+	CPU UART4, RS485 +(A) signal
Pin 6	RS232_3_RXD	CPU UART3, RS232 RXD signal
Pin 5	RS232_3_TXD	CPU UART3, RS232 TXD signal
Pin 4	RS232_1_RXD	CPU UART1, RS232 RXD signal
Pin 3	RS232_1_TXD	CPU UART1, RS232 TXD signal
Pin 2	GND	System Ground
Pin 1	+5V	System 5V output, up to 1A

Table 22 Connectivity Section

2(1,2)UART2 signal is used by the onboard WiFi/BT module, so the I/O port function is disabled by default. If you need the I/O port function instead, please contact Chipsee Technical Support at support@chipsee.com for assistance.

 **Note**

120Ω termination resistors are not mounted or included with the device.

USB Connectors

There are 2 x Type A **USB HOST connectors** onboard, as shown on the figure below.



Figure 67: *USB HOST Connectors*

Note

The USB HOST connectors can drive at most 500mA current on each dual port.

There is also 1 x Type Mini B **USB OTG connector**, configured as slave by default.



Figure 68: *USB OTG Connector*

LAN Connectors

LAN (RJ45) connector provides Ethernet connectivity over standardized Ethernet cables. The integrated Ethernet interface supports up to 1 Gbps data throughput. Power over Ethernet (PoE) is not supported.



Figure 69: *Rj45 LAN Connector*

Note

Use CAT5 or better cables to achieve full data throughput over maximum distance defined by the 1000BASE-T standard (100m).

WiFi & BT Module

The PPC-A9-121-U-C Industrial Panel PC is equipped with the popular **Realtek RTL8723 WiFi/BT module** that supports BT/BLE 4.0 (with backward compatibility), as well as 802.11bgn 2.4 GHz Wireless LAN (WLAN). The product includes an SMA connector for an external WiFi/BT antenna, as illustrated in the figure below.



Figure 70: WiFi+BT Antenna

4G/LTE Module

The PPC-A9-121-U-C Industrial Panel PC is equipped with a **mini-PCIe connector** that can connect to a 4G/LTE module. The customer will also need a SIM Card Holder and a 4G/LTE Antenna Connector to ensure 4G/LTE works on the PPC-A9-121-U-C. SIM card does **NOT** support hot plug. **Power off** before inserting or removing SIM card.

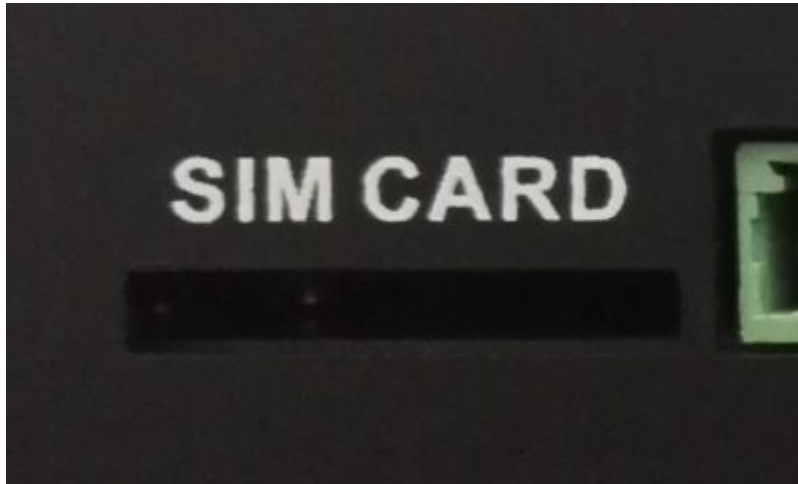
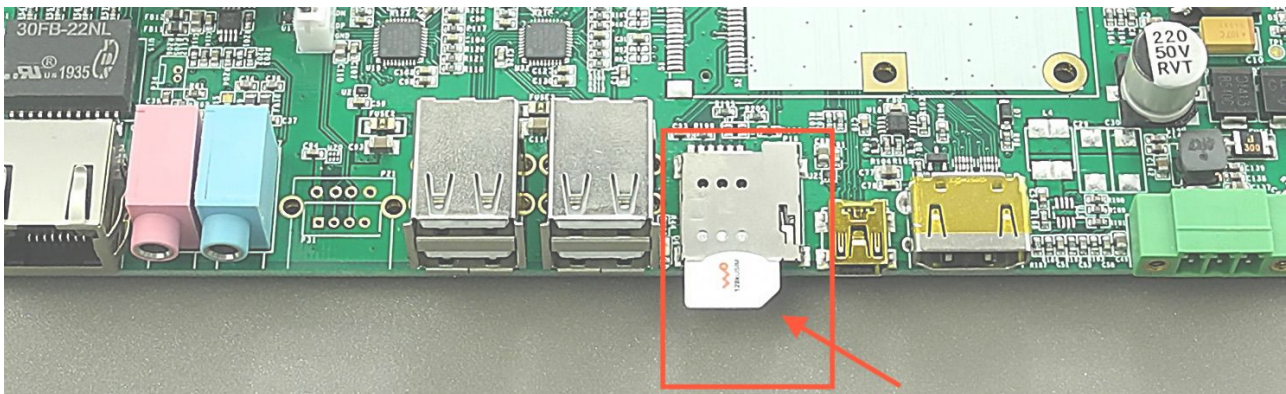

Figure 71: SIM Card Holder



SIM Card Direction

Attention

1. The product does not come shipped with the 4G/LTE module by default.
2. Also, there is no software driver for any kind of 4G/LTE module on Chipsee store.

Camera, Microphone, and Fingerprint Module

The PPC-A9-121-U-C Industrial Panel PC supports a camera, a Microphone audio input, and a Zaz-070S fingerprint module as shown on the figure below.

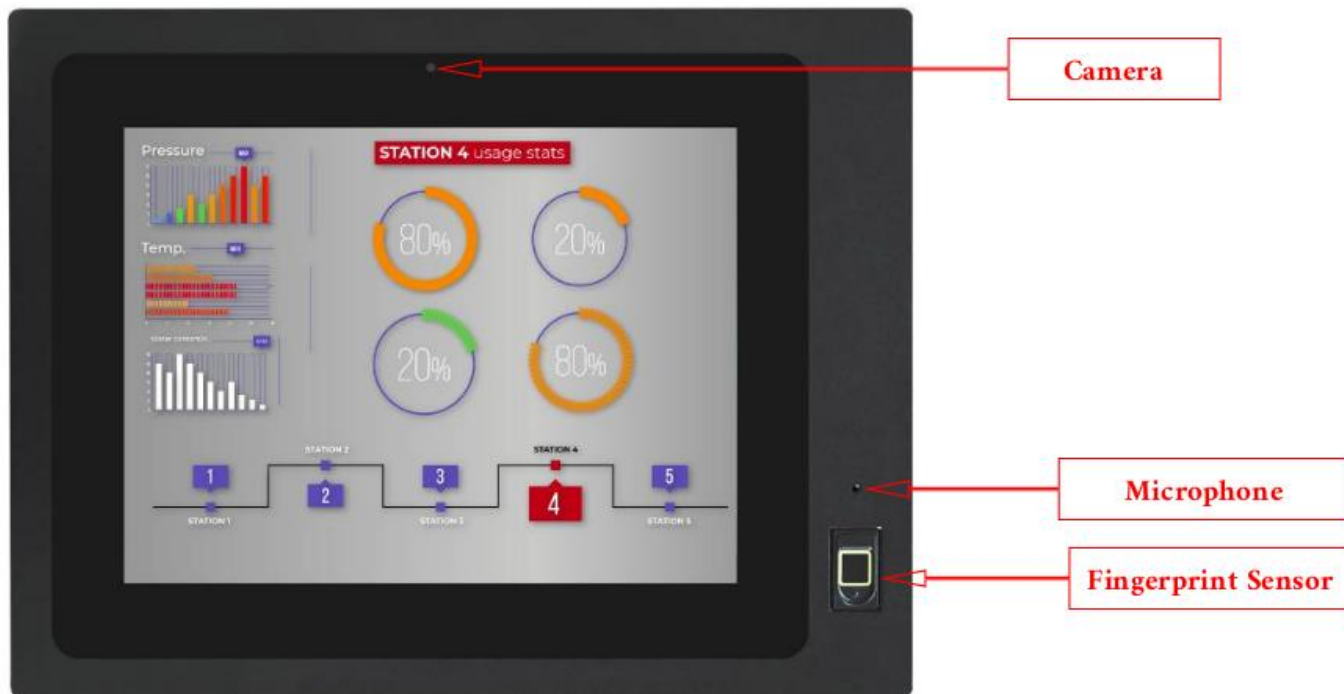

Figure 72: Camera, Mic, and Fingerprint module

Attention

The camera is not mounted by default.

Audio Connector

The PPC-A9-121-U-C Industrial Panel PC features some audio peripherals, as well. It has 1 x **3.5mm audio output jack**.

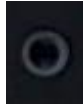

Figure 73: *Audio Out Connector*

HDMI Connector

The PPC-A9-121-U-C Industrial Panel PC is equipped with 1 x **HDMI connector**. The HDMI connector allows connecting an additional (external) monitor. HDMI output resolution can be configured by the software.

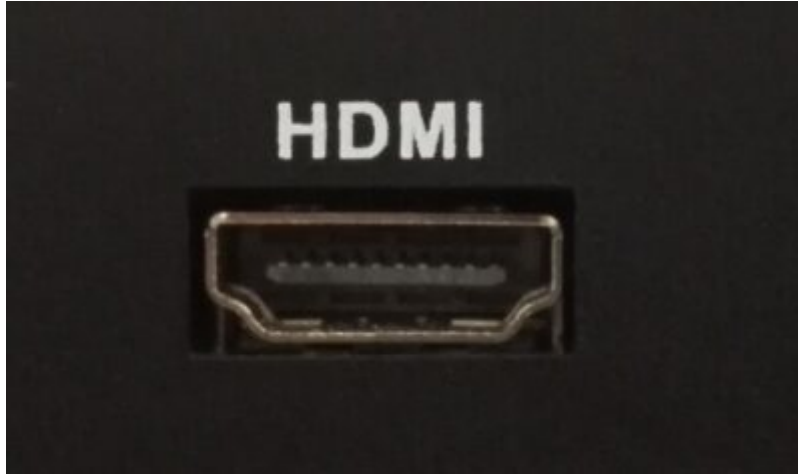

Figure 74: *HDMI Connector*

Boot DIP Switch

The PPC-A9-121-U-C Industrial Panel PC supports boot from SD card. If you want to re-flash the Operating System (OS), you can use the TF card for that purpose, combined with the **DIP switch** settings as illustrated in the figure below.

There is no need to alter the DIP switch settings during regular operation. However, if you need to reinstall the OS, please refer to the table below. Detailed information on how to re-flash the OS can be found in the [Software Documentation](#).

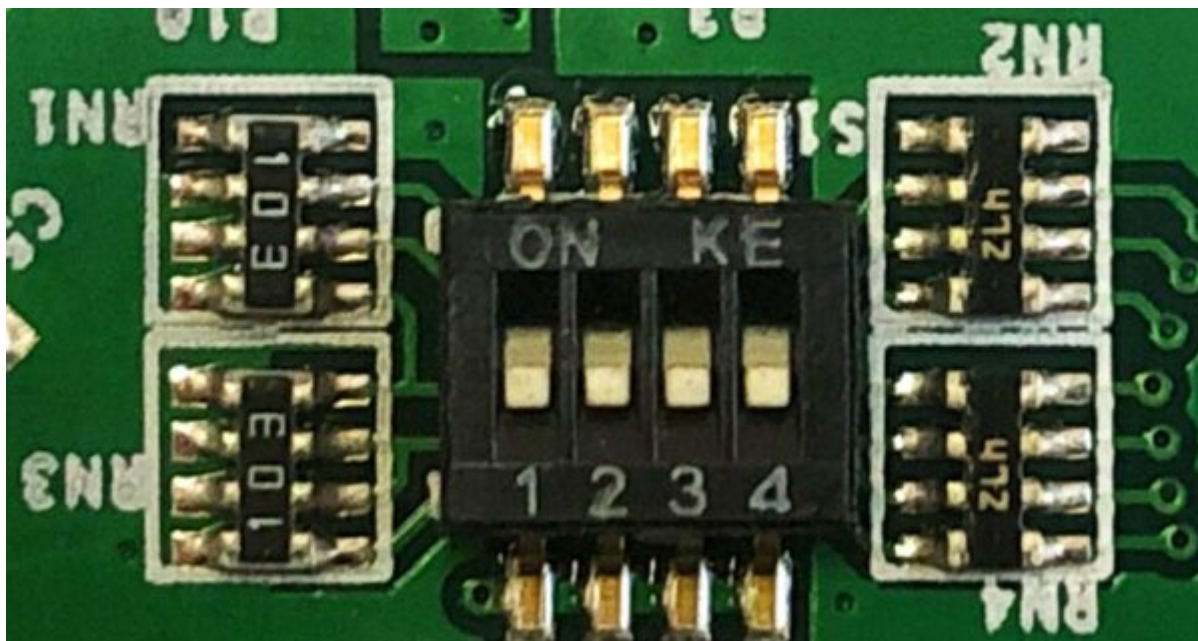

Figure 75: Boot DIP Switch

Boot Config Select				
DIP SW	1	2	3	4
SD	1	0	0	0
eMMC	1	1	0	1
Download	0	1	1	0

Table 23 Boot Configuration Selection

Mounting Procedure

The PPC-A9-121-U-C Industrial Panel PC can be mounted using the VESA (100x100mm or 75x75mm) and Panel mounting methods with a 4 x M4 screws, enabling simplified installation onto any standard mounting fixture.

You can mount PPC-A9-121-U-C with the VESA mounting method, as shown on the figure below.

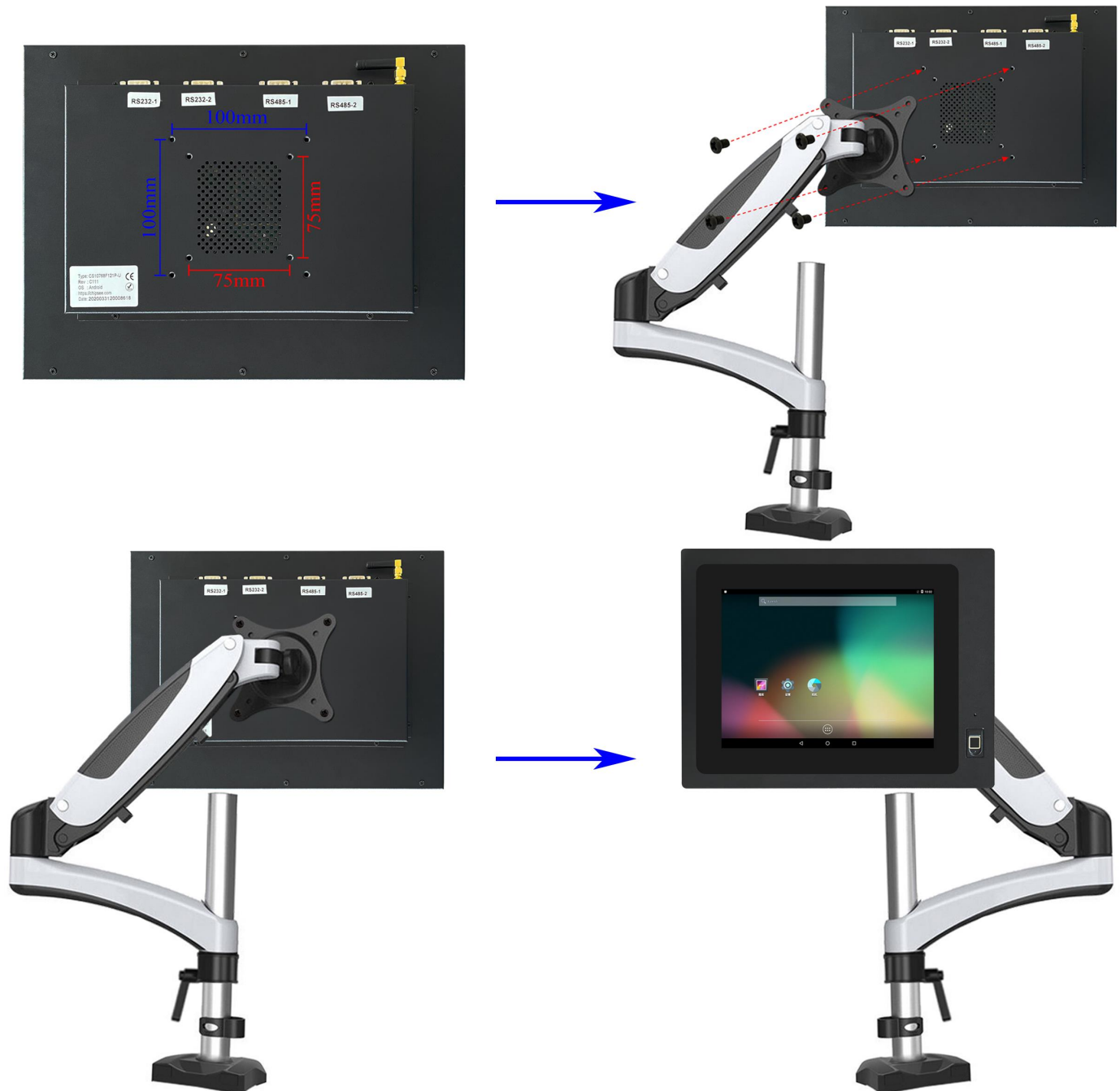

Figure 76: VESA mounting

You can mount PPC-A9-121-U-C with the Panel mounting method, as shown on the figure below.

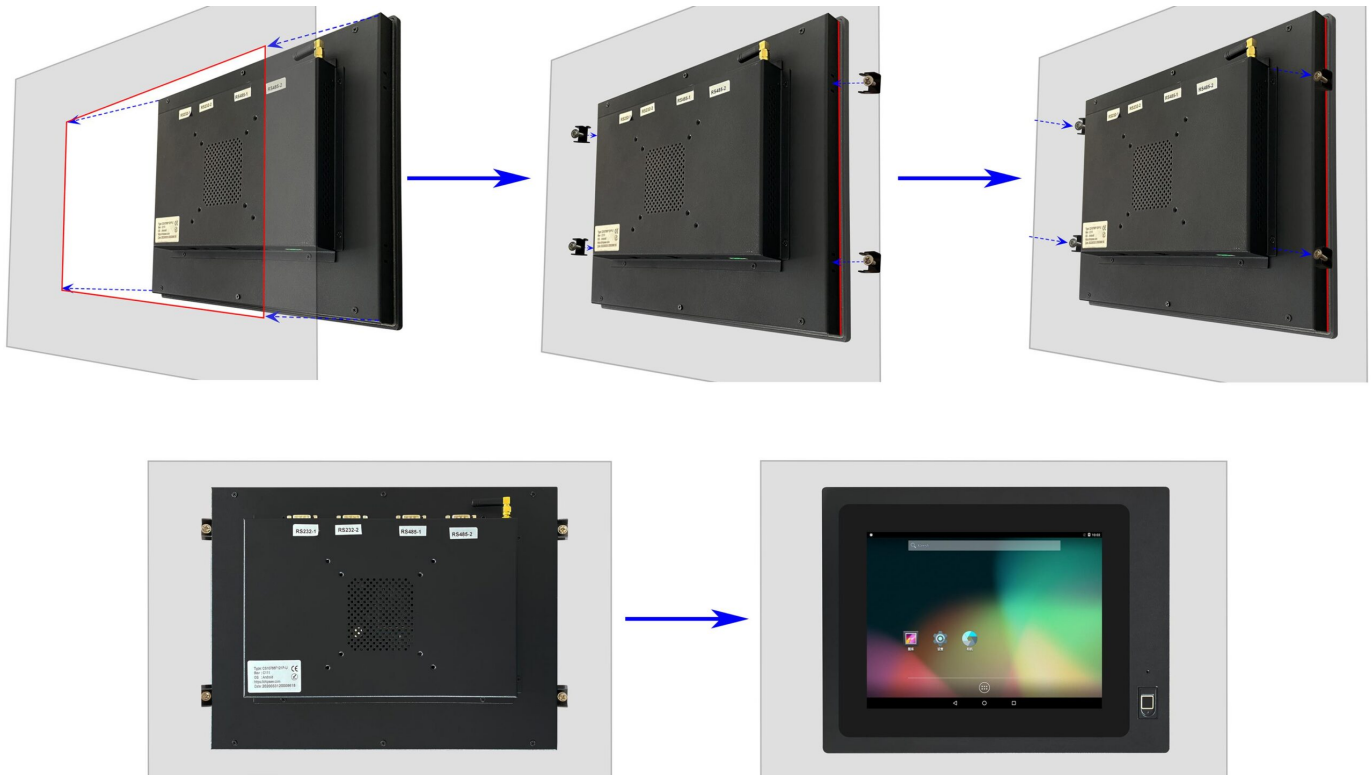

Figure 77: Panel mounting

Note

The operator can fix the PC into the panel by pushing it from the front inside the panel as described in the figure above. The recommended maximum thickness of the panel material is 8mm.

1. Make sure the Panel PC is configured correctly. The Boot Switch is sitting inside the housing. To use it, the Panel PC has to be unmounted from the panel.
2. Push the Panel PC straight into the Panel Hole until the unit sits flat on the panel as shown in the figure above.
3. Use the mounting fixtures to lock the Panel PC into its place.

Attention

Please make sure the display is not exposed to high pressure when mounting into an enclosure.

You can find detailed information about mounting in the [Mount IPC Guide](#).

Mechanical Specifications

The outer mechanical dimensions of PPC-A9-121-U-C are 359 x 274 x 23mm (W x L x H). Please refer to the technical drawing in the figure below for details related to the specific product measurements.



Figure 78: Technical Drawing

Disclaimer

This document is provided strictly for informational purposes. Its contents are subject to change without notice. Chipsee assumes no responsibility for any errors that may occur in this document. Furthermore, Chipsee reserves the right to alter the hardware, software, and/or specifications set forth herein at any time without prior notice and undertakes no obligation to update the information contained in this document.

While every effort has been made to ensure the accuracy of the information contained herein, this document is not guaranteed to be error-free. Further, it does not offer any warranties or conditions, whether expressed orally or implied in law, including implied warranties and conditions of merchantability or fitness for a particular purpose. We specifically disclaim any liability with respect to this document, and no contractual obligations are formed either directly or indirectly by this document.

Despite our best efforts to maintain the accuracy of the information in this document, we assume no responsibility for errors or omissions, nor for damages resulting from the use of the information herein. Please note that Chipsee products are not authorized for use as critical components in life support devices or systems.

Technical Support

If you encounter any difficulties or have questions related to this document, we encourage you to refer to our other documentation for potential solutions. If you cannot find the solution you're looking for, feel free to contact us. Please email Chipsee Technical Support at support@chipsee.com, providing all relevant information. We value your queries and suggestions and are committed to providing you with the assistance you require.