

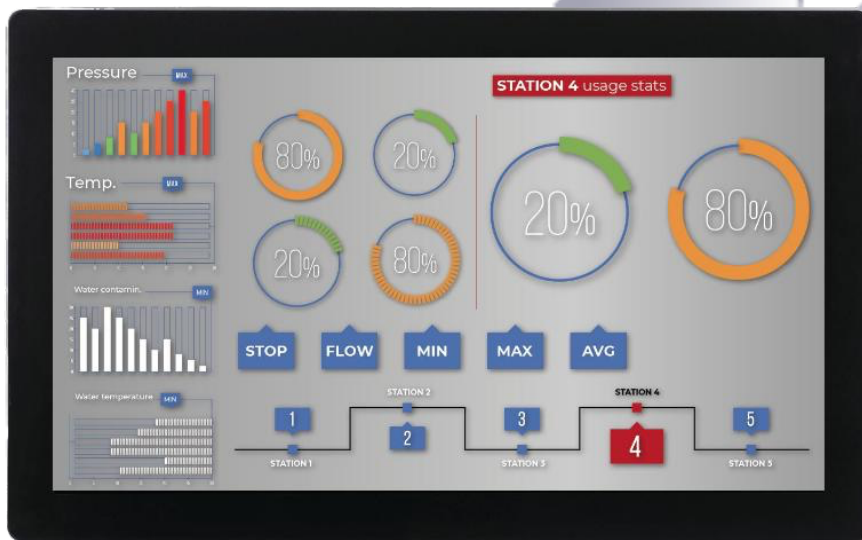

Industrial PC

PPC-A72-215-C



PN: CS19108R215P

Content can change at anytime, check our website for latest information of this product.

www.chipsee.com

Contents

PPC-A72-215-C	3
1. Product Overview	7
2. Ordering Options	8
2.1. Operating System	8
2.2. Optional Features	9
3. Hardware Features	10
4. Power Input	12
5. Touch Screen	13
6. Connectivity	14
6.1. DB9 Connectors	14
6.2. USB Connectors	14
6.3. LAN Connectors	16
6.4. WiFi & BT Module	17
6.5. 4G/LTE Module	18
6.6. Expansion Connector	19
7. TF Card Slot	21
8. Audio Connectors	22
9. HDMI Connector	23
10. Power Button	24
11. Measurements and Mounting Procedure	25
12. Disclaimer	27
13. Technical Support	27

PPC-A72-215-C

Front View

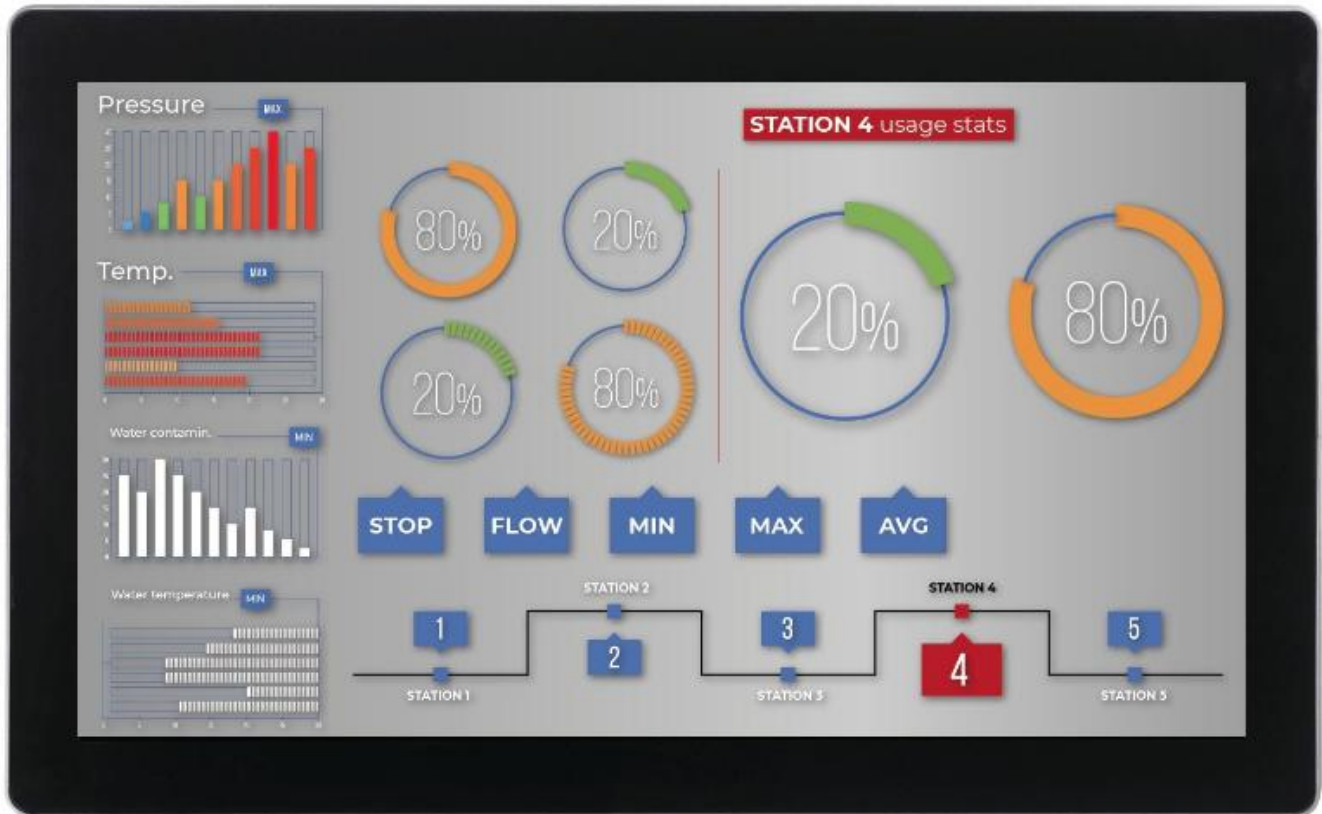

Rear View



Side View 1



Side View 2



Product Overview

The Cortex[®]-A72/53 series PPC-A72-215-C (PN: CS19108R215P) is a high-quality industrial panel PC. It features a 21.5" ten-point capacitive touch screen with a resolution of 1920 x 1080 pixels and brightness of 250 cd/m².

Key Applications

- Human Machine Interface HMI
- Mobile Applications
- Video Processing
- Machine Learning
- Video Gaming
- Process Control
- Process Monitoring
- ATM...

It is available both as an embedded solution and as a device housed in an aluminum casing with bezels, thus facilitating different installation options:

- Installation on an industrial cabinet
- Integration with the existing equipment

The PPC-A72-215-C Industrial Panel PC is based around the powerful CS-SOM-RK3399 System on Module (SoM), powered by the Rockchip RK3399 low-power processor which integrates a dual-core Cortex[®]-A72 and a quad-core Cortex[®]-A53 with a separate NEON coprocessor.

The RK3399 supports multi-format video decoders and has a high-performance dual-channel external memory interface (DDR3/DDR3L/LPDDR3/LPDDR4) capable of sustaining demanding memory bandwidths. It also provides a complete set of peripheral interfaces.

Ordering Options

Chipsee products can be customized during the ordering process. The product will be shipped with the pre-installed factory defaults if no extra requirements are specified. The table in the [Hardware Features](#) section provides information about the default options bundled with the product.

Note

You can order [PPC-A72-215-C](#) from the official [Chipsee Store](#) or from your nearest distributor.

Operating System

This product comes with a pre-installed OS of your choice. Please see the list below for the supported OSes, which can be also obtained from the [Software Documentation](#) section, along with the detailed installation instructions.

- Buildroot Linux Qt5.14*
- Android 7.1
- Debian 10

* (Formerly Chipsee Linux) Based on buildroot that has been integrated with:

1. Chipsee Hardware Test Application
2. An initialization script for GPIO/Buzzer/Audio
3. Multiple libraries, such as the `libQt5Sql` to develop Qt application with SQL
4. Various packages, such as the `ntfs-3g` to use NTFS file system

Warning

The [Software Documentation](#) section provides a detailed instruction on how to install different OSes on your own. However, bear in mind that Chipsee can't take the responsibility of inadequate installation procedure. If you "brick" your device, please contact Chipsee Technical Support at support@chipsee.com for further assistance

Optional Features

The PPC-A72-215-C Industrial Panel PC does not include 4G/LTE module by default. The module is optional and can be selected at the Chipsee store during the ordering process.

Warning

Installation, repair, and maintenance tasks should be performed by trained personnel only.
Chipsee does not bear any responsibility for damage caused by inadequate handling of the product.

Hardware Features

The PPC-A72-215-C Industrial Panel PC offers a broad range of performance and connectivity options for scalable integration, providing expandability to meet future needs. Some of the key features are listed in the table below.

PPC-A72-215-C	
CPU	Rokchip RK3399, Dual-core Cortex-A72 (1.8GHz), Quad-core Cortex-A53 (1.4GHz)
RAM	4GB DDR3
eMMC	16GB
Storage	TF Card, Supports up to 32GB SDHC
Display	21.5" LCD, 1920 x 1080, High Brightness: 250 cd/m ²
Touch	10-point capacitive touch screen
USB	4 x USB 2.0 HOST, 1 x USB 3.0 HOST, 1 x USB Type-C
LAN	1 x RJ45, GbE
Audio	3.5mm Audio Out Connector, 2W Internal Speaker
Buzzer	Yes
RTC	Yes
RS232	5 x RS232 ¹
RS485	2 x RS485 (4 at most, 1 debug port) ¹
GPIO	8 Channels
WiFi/BT	Integrated WiFi/BT Module
HDMI	1 x HDMI
4G/LTE	Supported, Optional
Power Input	From 15V to 36V
Current at 15V	1000mA Max
Power Consumption	15W Typical
Working Temperature	From 0°C to +70°C
OS	Android 7.1
Dimensions	530 x 322 x 45mm
Weight	6000g
Mounting	VESA & Panel methods

Table 144 Key Features

1(1,2)This product has 7 x UART channels in total. The default configuration is 5 x RS232 and 2 x RS485. UART can be swapped between RS232 and RS485 modes easily, so if you need different RS232/RS485 configuration, please get in touch with the Chipsee Technical Support at support@chipsee.com

Power Input

The PPC-A72-215-C Industrial Panel PC can be powered by a wide range of input voltages: From 15V to 36V DC. The power input connector is a **3-pin, 3.81mm terminal**. The polarity and the pinout is clearly marked on the housing of the product as shown on the figure below.

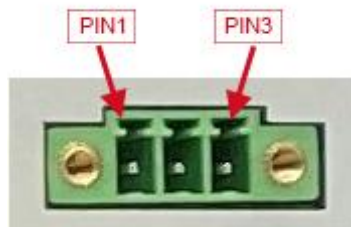

Figure 573: Power Input

Note that the “+” sign represents the positive power input, and it is printed both at the casing and as a silk-screen on a PCB of the embedded version. The “-” terminal is shorted to the ground.

Power Input Definition		
Pin Number	Definition	Description
Pin 1	Positive Input	DC Power Positive Terminal
Pin 2	Negative Input	DC Power Negative Terminal
Pin 3	Ground	Power System Ground

Table 145 Power Connector

Note

The system ground “**G**” is connected to power negative “-” on board.

Touch Screen

The PPC-A72-215-C Industrial Panel PC uses a 10-point capacitive touch screen.

Attention

A capacitive touch screen is susceptible to power noise and Electromagnetic Radiation (EMR). It may cause LCD ripples or even capacitive touch malfunction. If using a capacitive multi-touch test application, you might notice the touch points float erratically across the display. There are several solutions to this problem:

1. Use a high-quality Power Adapter Unit (PSU) with low EMR. You can also provide power from a battery.
2. Make sure that the PPC-A72-215-C Power Input connector (pin 3) is properly connected to the Power System Ground to provide sufficient EMI shielding and eliminate the problem entirely.
3. Bad GND problem can also be confirmed by touching pin 3 of the Power Input connector with one hand while operating the capacitive touch screen with the other hand. In this case, the operator's body acts as the Power System Ground.

Connectivity

There are many connectivity options available on the PPC-A72-215-C industrial PC. It has 4 x USB 2.0 HOST, 1 x USB 3.0 HOST, 1 x USB Type-C, 1 x RJ45, GbE Ethernet connector, and 6 x DB9 connectors.

DB9 Connectors

The PPC-A72-215-C Industrial Panel PC has 6 x DB9 connectors that are configured as RS232 by default as shown on the figure below. You can configure **COM3/COM4/COM5/COM6** as RS485. If you need different RS232/RS485 configuration, contact the Chipsee Technical Support at support@chipsee.com.

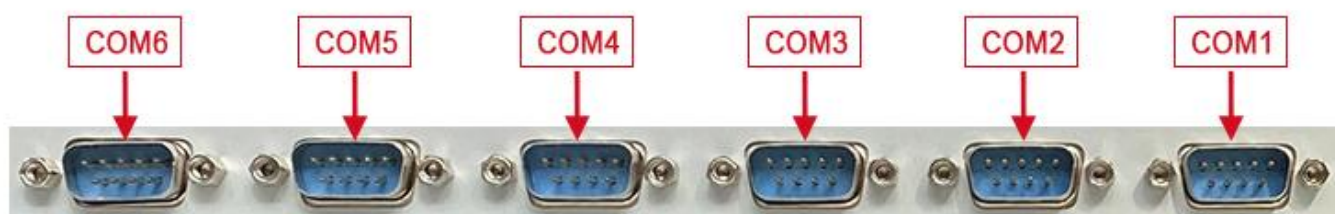

Figure 574: DB9 Connectors

USB Connectors

There are 4 x dual **USB 2.0 HOST connectors** onboard, as shown on the figure below.



Figure 575: USB 2.0 HOST Connectors

There is also 1 x **USB 3.0 HOST connector** and 1 x **USB Type-C connector**, as shown below.



Figure 576: USB 3.0 HOST Connector



Figure 577: *USB Type-C Connector*

LAN Connectors

LAN (RJ45) connector provides Ethernet connectivity over standardized Ethernet cables as shown the figure below. The integrated Ethernet interface supports up to 1 Gbps data throughput.



Figure 578: *RJ45 LAN Connector*

Note

Use CAT5 or better cables to achieve full data throughput over maximum distance defined by the 1000BASE-T standard (100m).

WiFi & BT Module

The PPC-A72-215-C Industrial Panel PC is equipped with the popular **Realtek RTL8723 WiFi/BT module** that supports BT/BLE 4.0 (with backward compatibility), as well as 802.11bgn 2.4 GHz Wireless LAN (WLAN).

The product includes an SMA connector for an external WiFi/BT antenna, as illustrated in the figure below.

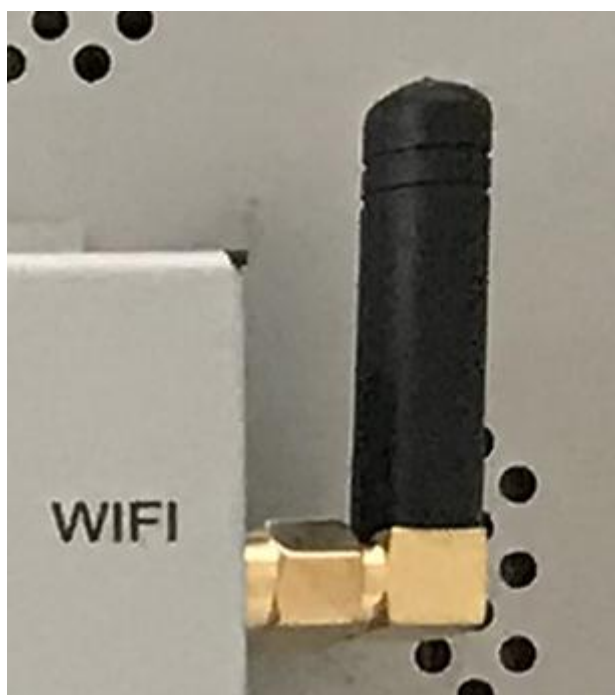

Figure 579: WiFi+BT Antenna

4G/LTE Module

The PPC-A72-215-C Industrial Panel PC is equipped with a **mini-PCIe connector** that can connect to a 4G/LTE module. The customer will also need a SIM Card Holder and a 4G/LTE Antenna Connector to ensure 4G/LTE works on the PPC-A72-215-C.

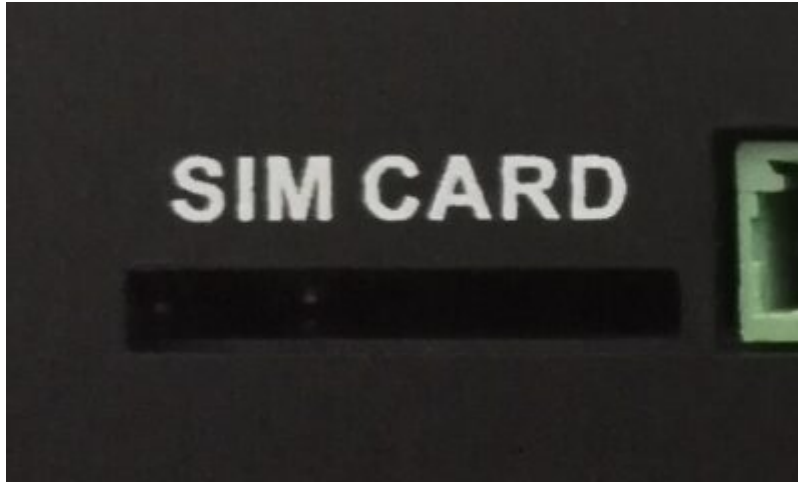

Figure 580: *SIM Card Holder*

Attention

The product does not come shipped with the 4G/LTE module by default.

Expansion Connector

The PPC-A72-215-C Industrial Panel PC has 1 x **Expansion Connector** (closed by default), as shown on the figure below. This connector has connected to isolated GPIO signals. The table below gives details about the definition of every Pin.



Figure 581: Expansion Connector

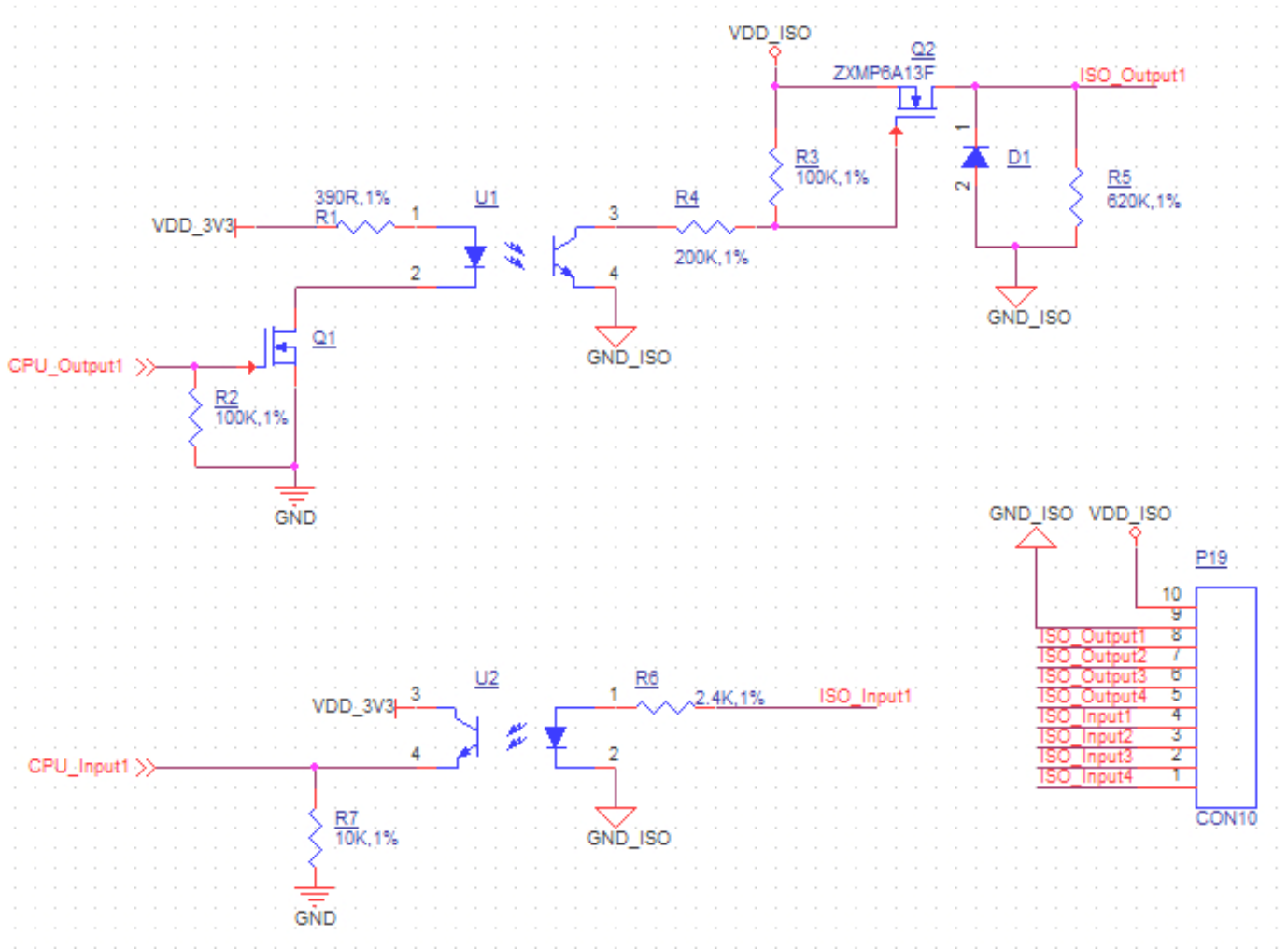

Isolated GPIO reduced schematic

Expansion Connector Pinout			
PIN	Function	PIN	Function
1	VDD, Isolated Power Input (+5V - +24V)	2	GND_ISO
3	OUT1	4	OUT2
5	OUT3	6	OUT4
7	IN1	8	IN2
9	IN3	10	IN4

Table 146 Expansion Connector Pinout

 **Warning**

Since the PCB traces of the port are connected to the processor directly, be careful not to cause electrostatic discharge or over voltage on the pins, as it may damage the processor. Take all the necessary precautions while working with electrostatic-sensitive equipment.

TF Card Slot

The PPC-A72-215-C Industrial Panel PC features 1 x **TF Card (micro SD) slot**. It can address up to 32GB of memory.



Figure 582: *TF (micro SD) Card Slot*

Note

The product does not come shipped with the TF Card by default.

Audio Connectors

The PPC-A72-215-C Industrial Panel PC features some audio peripherals, as well. It has 1 x **3.5mm audio output jack**.



Figure 583: *Audio Out Connector*

HDMI Connector

The PPC-A72-215-C Industrial Panel PC is equipped with 1 x **HDMI connector**. The HDMI connector allows connecting an additional (external) monitor. HDMI output resolution can be configured by the software.



Figure 584: *HDMI Connector*

Power Button

The PPC-A72-215-C Industrial Panel PC has a power button, as shown on the figure below. You can use the button to power ON or OFF the industrial PC.



Figure 585: *Power button*

Measurements and Mounting Procedure

The outer mechanical dimensions of PPC-A72-215-C are 530 x 322 x 45mm (W x L x H). Please refer to the technical drawing in the figure below for details related to the specific product measurements.

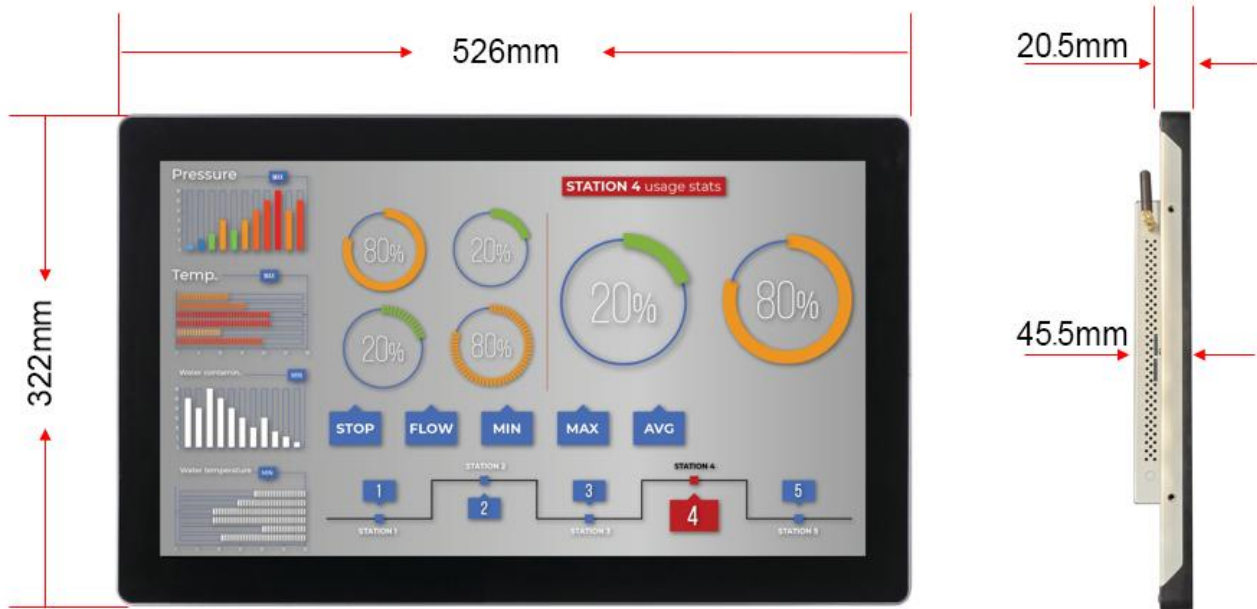

Figure 586: PPC-A72-215-C *Technical Drawing*

The PPC-A72-215-C Industrial Panel PC can be mounted with 8 x M4 screws or 4 x M4 screws using the VESA (100x100cm or 75x75cm) and Panel mounting methods, enabling simplified installation onto any standard mounting fixture.

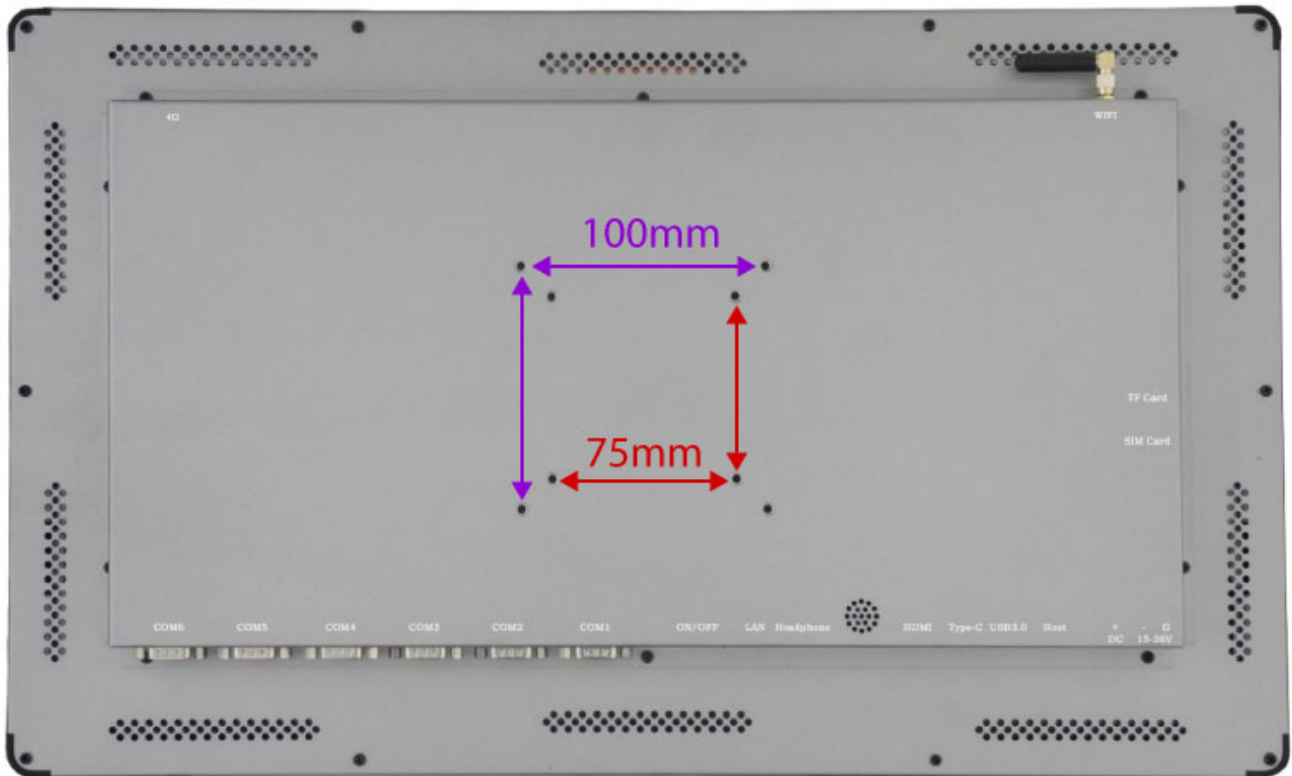

Figure 587: *Mounting Method*

 **Note**

Please make sure the display is not exposed to high pressure when mounting into an enclosure.

You can find detailed information about mounting in the [Mount IPC Guide](#).

Disclaimer

This document is provided strictly for informational purposes. Its contents are subject to change without notice. Chipsee assumes no responsibility for any errors that may occur in this document. Furthermore, Chipsee reserves the right to alter the hardware, software, and/or specifications set forth herein at any time without prior notice and undertakes no obligation to update the information contained in this document.

While every effort has been made to ensure the accuracy of the information contained herein, this document is not guaranteed to be error-free. Further, it does not offer any warranties or conditions, whether expressed orally or implied in law, including implied warranties and conditions of merchantability or fitness for a particular purpose. We specifically disclaim any liability with respect to this document, and no contractual obligations are formed either directly or indirectly by this document.

Despite our best efforts to maintain the accuracy of the information in this document, we assume no responsibility for errors or omissions, nor for damages resulting from the use of the information herein. Please note that Chipsee products are not authorized for use as critical components in life support devices or systems.

Technical Support

If you encounter any difficulties or have questions related to this document, we encourage you to refer to our other documentation for potential solutions. If you cannot find the solution you're looking for, feel free to contact us. Please email Chipsee Technical Support at support@chipsee.com, providing all relevant information. We value your queries and suggestions and are committed to providing you with the assistance you require.